

This manual is for reference and historical purposes, all rights reserved.

This page is copyright© by M. Butkus, NJ.

This page may not be sold or distributed without the expressed permission of the producer

I have no connection with any camera company

On-line camera manual library

This is the full text and images from the manual. This may take 3 full minutes for the PDF file to download.

If you find this manual useful, how about a donation of \$3 to: M. Butkus, 29 Lake Ave., High Bridge, NJ 08829-1701 and send your e-mail address so I can thank you. Most other places would charge you \$7.50 for a electronic copy or \$18.00 for a hard to read Xerox copy.

This will allow me to continue to buy new manuals and pay their shipping costs.

It'll make you feel better, won't it?

**If you use Pay Pal or wish to use your credit card,
click on the secure site on my main page.**

Canon AT-1



E

English Edition
INSTRUCTIONS

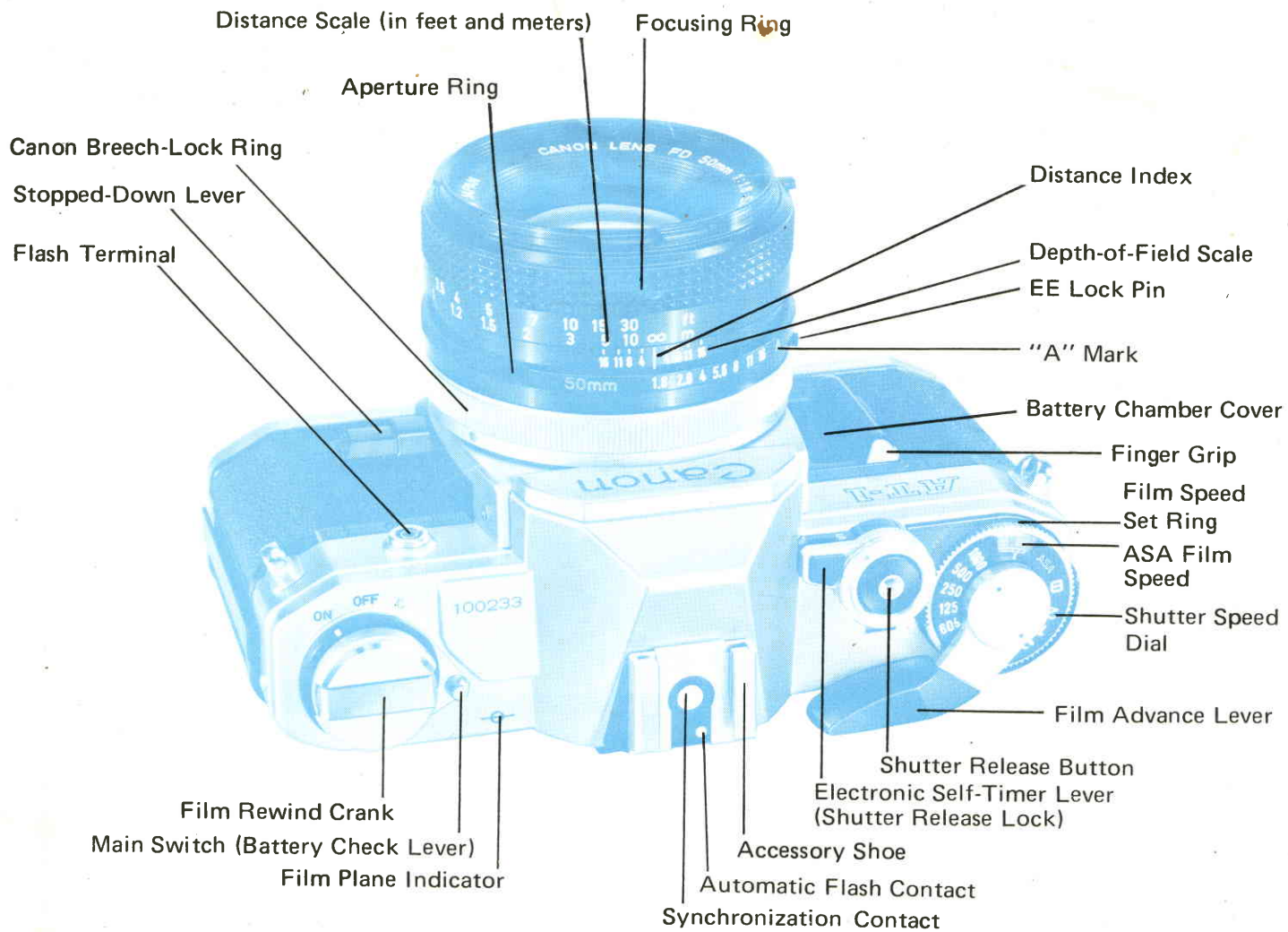

While reading the instruction booklet, unfold this flap and the flap on the back cover to facilitate your understanding of the instructions.

PICTORIAL OUTLINE FOR USING THE CAMERA

- 1 Load the battery.
Turn the main switch on.

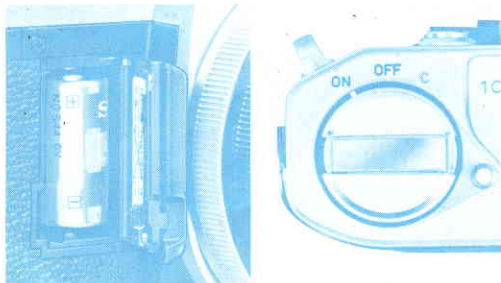

- 2 Load the film.

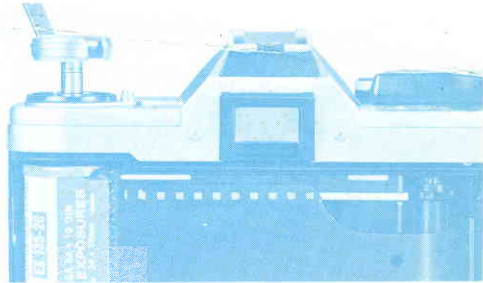

- 5 Look into the viewfinder.
Compose the picture and focus.

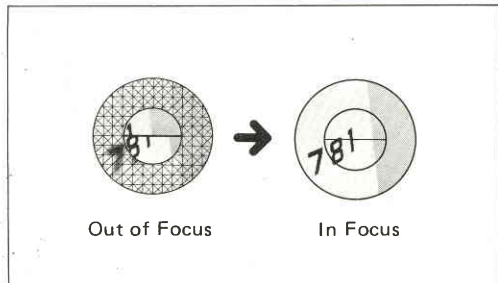

- 6 Determine the exposure by adjusting the shutter speed dial and the aperture ring.



Congratulations upon the purchase of your new Canon AT-1, a remarkably advanced camera that reflects the latest trends in SLR photography. As a flawless product of Canon technology, its vast potential as a rewarding means of expression is assured for years to come by an incomparable system of fine lenses and accessories.

At an extremely reasonable price, the Canon AT-1 offers you through-the-lens Central Emphasis Metering plus many of the superb advantages enjoyed by users of its all-electronic counterpart, the Canon AE-1. Its fabulous electronic system consisting of the Power Winder A for continuous rapid-fire shooting, the Speedlite 155A and 199A for perfectly synchronized flash shooting and the Data Back A for automatic data imprinting give the AT-1 unsurpassably versatile performance. Similarly, you have the entire system of

superior FD interchangeable lenses at your disposal which enable metering at full aperture.

But perhaps most conspicuous is the absence of mechanical noise that is characteristic of conventional SLRs. The AT-1 incorporates a wonderfully silent electromagnetic release, in addition to a 10-second electronic self-timer, for perfectly vibrationless operation. Moreover, you will surely find the Canon AT-1, with its extremely compact and lightweight body to be one of the easiest to operate cameras ever.

In order to derive full benefit from the many features the AT-1 affords, please take the time to read and understand the following instructions. Canon remains always ready to lend you its support in the future with a system of lenses and accessories unequaled the world over.

Use of the Camera in Extremely Cold Conditions

In temperatures below 0°C (32°F), the battery may be affected. It will work longer and better if you keep the camera warm until you are ready to shoot, but, if you shoot for a long period, the battery may still fail. For this reason, it is advisable to carry a spare battery. The spare should be kept warm in a pocket so that it will be ready in the event that it is needed. That the battery may not perform well in the cold does not necessarily mean it won't work normally again in warmer temperatures, so don't throw it away.

Protect the camera from the cold in any way possible and try to finish shooting as quickly as possible. Taking the camera directly from cold into warm temperatures, such as from outside into a room, will result in condensation which could cause corrosion. To avoid this, the camera should be placed in a completely sealed plastic bag and remain there until it gradually reaches room temperature.

Self-Timer Lamp

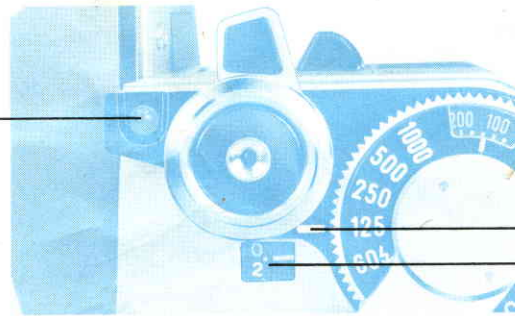

Shutter Speed Index

Frame Counter

Memo Holder

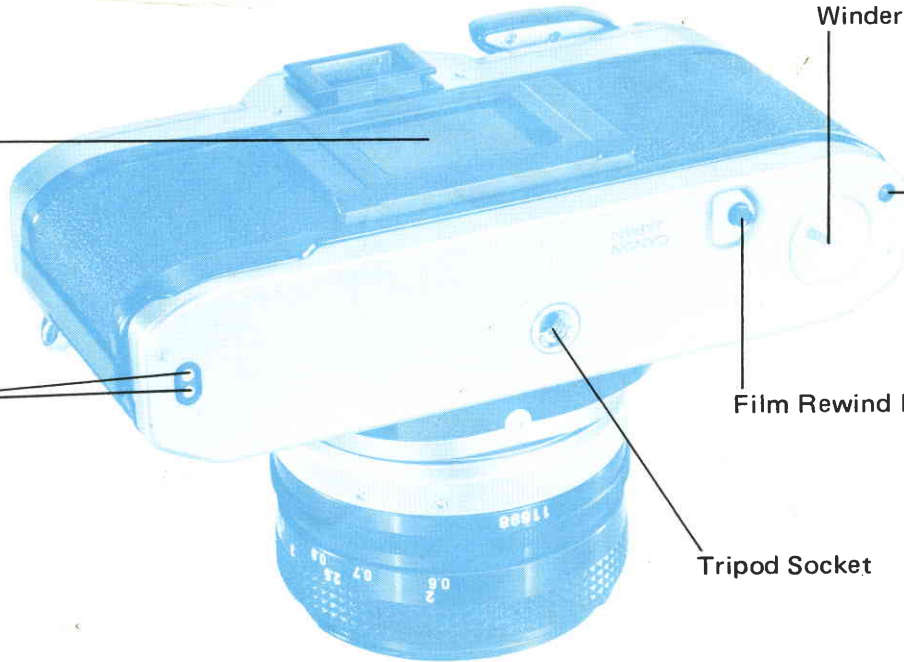

Winder Coupler Cover

Winder Guide Hole

Film Rewind Button

Tripod Socket

Winder Terminals

3 Set the ASA film speed.

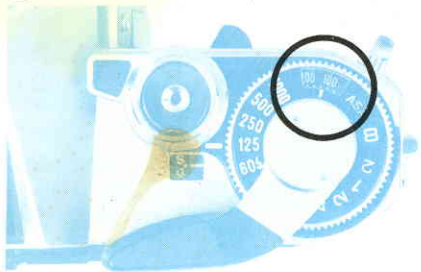

4 Advance the film.

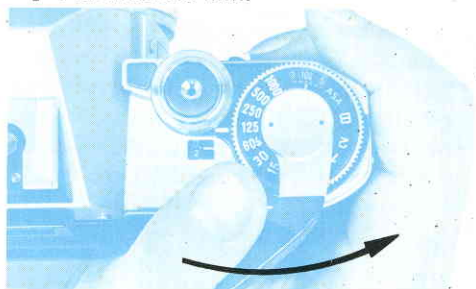

7 Press the shutter button.

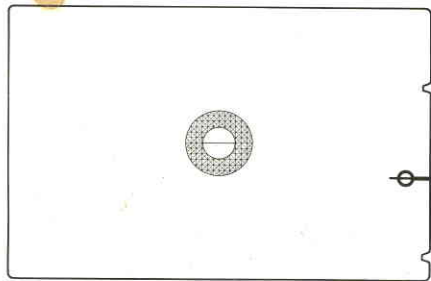
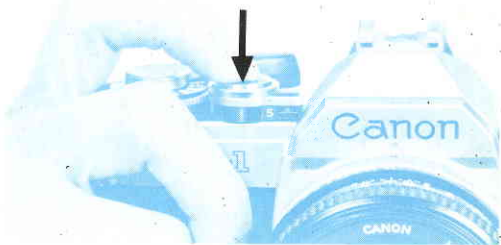

Photography with the Canon Speedlite 155A

1. Take off the battery chamber cover and load the batteries.
2. Set the ASA film speed of the 155A.
3. Mount the Speedlite 155A on the accessory shoe of the camera.
4. Turn the main switch on.
5. Set the AUTO/MANU. switch.
6. Set the prescribed f/stop on the lens.
7. Focus and press the shutter button.

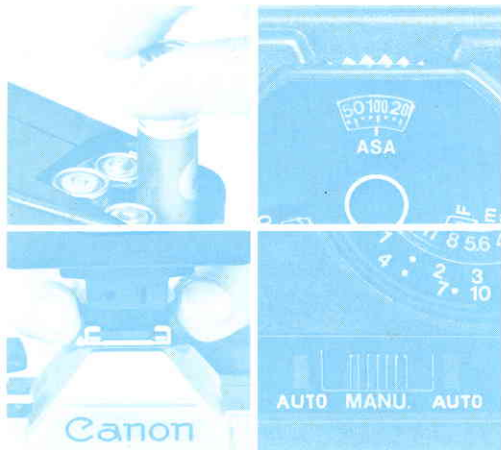

Photography with the Canon Power Winder A

1. Remove the Battery Pack A.
2. Load the batteries into the Battery Pack A.
3. Attach the Battery Pack A to the Power Winder A.
4. Take off the winder coupler cover on the bottom of the camera body and put it in the winder coupler's cover holder.
5. Attach the Power Winder A to the camera.
6. Turn the main switch on.
7. Focus and press the shutter button.

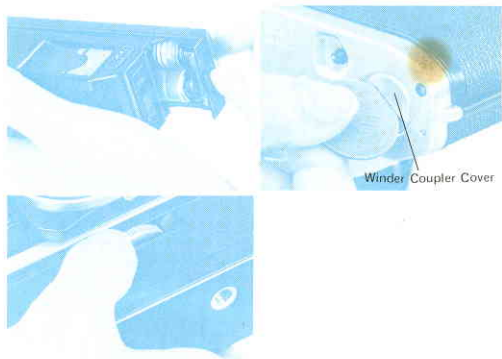

CONTENTS

SPECIFICATIONS	8-10	Depth-of-Field	45-46
Handling the Case and Lens Cap	12-13	Using the Self-Timer	47-48
Mounting the Lens	13	Flash Photography with the AT-1	49
Loading the Battery and Main Switch	14-15	Long Exposures	50
Checking the Battery	16	Stopped-Down Metering	52
Film Advance and Shutter Release	17-18	Manual Aperture Control	53-54
Loading the Film	19-20	Lenses	55-58
Frame Counter	21	ACCESSORIES, CARE OF THE CAMERA, MAINTENANCE, AND MISCELLANEA	59
Setting the ASA	22-23	Canon Speedlite 155A and 199A	61
OPERATION FOR GENERAL PHOTOGRAPHY	25	Canon Power Winder A	62
Selecting the Shutter Speed	27-28	Canon Data Back A and Auto Bellows	63
Lens Aperture	28	Other Accessories	64-65
Viewing and Focusing	29	Care and Storage of the Camera	67-69
Dioptric Adjustment Lenses	30		
Viewfinder Information	32		
Determining the Exposure	33		
Meter Coupling Range	35		
Holding the Camera	37		
Releasing the Shutter and Rewinding the Film	38-39		
DETAILED OPERATION OF THE AT-1	41		
Effects of Changing the Shutter Speed and the Aperture	43-44		

SPECIFICATIONS

Type: 35mm SLR (Single-Lens-Reflex)
Camera with focal plane shutter.

Picture Size: 24 x 36mm

Interchangeable lenses: Canon FD series lenses for full aperture metering. Canon FL series lenses for stopped-down metering.

Standard Lenses: Canon FD 55mm f/1.2 S.S.C.

Canon FD 50mm f/1.4 S.S.C.

Canon FD 50mm f/1.8 S.C.

Lens Mount: Canon Breech-Lock Mount.
Canon FD, FL, and R lenses can be mounted for use.

Viewfinder: Fixed eye-level pentaprism.

Field of View: 93.5% vertical and 96.3% horizontal coverage of the actual picture area.

Magnification: 1:0.82 at infinity with a standard 50mm lens.

Dioptric Adjustment Lens S: Standard -1 diopter.

Interchangeable with +3, +2, +1.5, +1, +0.5, 0, -0.5, -2, -3, and -4 diopters.

Focusing Screen: Split-image/microprism rangefinder surrounded by matte screen

Viewfinder Information: Meter needle and aperture needle (circular index) are seen on the right hand side of the viewfinder. On the upper right hand is an over-exposure/battery check index mark and on the lower right hand is a metering limit index mark on the underexposure side.

Viewfinder Attachments: Angle Finder A2 and B, Magnifier S, Dioptric Adjustment Lens S (10 kinds), and Eyecup 4S.

Mirror: Instant-return, large reflector mirror with shock absorbing mechanism.

Exposure Meter: Built-in. Using CdS photocell. Coupled to shutter speeds, film speeds, and f/stops. Match needle type, TTL full aperture metering mechanism.

Light Metering System: TTL (Through-The-Lens) Central Emphasis Metering method

Exposure Meter Coupling Range: EV 3 (f/1.4 at 1/4 sec.) to EV 17 (f/16 at 1/500 sec.) at ASA 100 film with FD 50mm f/1.4 S.S.C. Lens.

Film Speed Range: ASA 25 to ASA 3200

Shutter: Cloth focal plane shutter with four spindles. Shock and noise damping mechanisms are incorporated. All shutter speeds are electronically controlled.

Shutter Speeds: 1/1000, 1/500, 1/250, 1/125, 1/60, 1/30, 1/15, 1/8, 1/4, 1/2, 1, 2 (seconds) and B.

X synchronization is at 1/60 seconds.

Shutter Speed Dial: The shutter speed dial is on the same axis as the film advance lever. The number 2 for two seconds is marked in orange; other numbers as well as X synchronization are in white. There is a shutter dial guard to prevent unintentional movement of the dial. The ASA dial is located underneath the shutter speed dial.

Self-Timer: Electronically controlled self-timer. After the self-timer lever is pushed forward, the self-timer is activated by the shutter release button. The self-timer releases the shutter after a time lag of 10 seconds. A self-timer LED lamp blinks on and off when the self-timer is in operation. The self-timer operation can be cancelled while in operation.

Stopping-Down the Lens: Stopping-down the lens can be performed by pushing the stopped-down lever after setting the aperture ring.

Power Source: One 6V silver oxide battery; Eveready No. 544, UCAR No.544, JIS 4G13, and Mallory PX28. The battery lasts the equivalent of 20,000 shutter releases, or one year under normal use.

Battery Check: Battery power level can be checked by the meter needle inside the viewfinder when the main switch is turned to the battery check index mark "C".

Flash Synchronization: X synchronization is at 1/60 sec. M synchronization is at 1/30 sec. and below.

Flash Terminal: The accessory shoe has a direct flash contact and automatic flash control contact. On the front of the camera body is the flash terminal, JIS-B type for flash units with a cord. It has a built-in protective rim to prevent electrical shock.

Automatic Flash: With the Canon Speedlite 155A or 199A, set the aperture to the

f/stop, and the amount of light is automatically controlled for correct flash exposure, adjusting the shutter speed to 1/60 of a second automatically.

Back Cover: The camera's back cover has a memo holder for your convenience. The cover can be removed for attaching the Canon Data Back A.

Film Loading: Performed by pulling up the rewind crank to open the back cover. Easy film loading with multi-slot take-up spool.

Film Advance Lever: Single stroke with 120° throw and 30° stand-off. The film can be wound with several short strokes. The Canon Power Winder A can be mounted for automatic winding of the film.

Frame Counter: Additive type. Automatically resets when the back cover is opened. While rewinding film, it counts back the frame numbers.

Film Rewinding: Performed by pressing the rewind button on the bottom and by using the rewinding crank on the top. The rewind button is automatically reset when the film is advanced with the film

advance lever.

Size: 141 x 87 x 47.5mm (5-9/16" x 3-7/16" x 1-7/8") body only.

Weight: 590g (20-13/16 ozs.) body only.
790g (27-7/8 ozs.) with the 50mm f/1.8 S.C. lens.
895g (31-9/16 ozs.) with the 50mm f/1.4 S.S.C. lens.
1,100g (38-13/16 ozs.) with the 55mm f/1.2 S.S.C. lens.

Subject to change without notice.



PRELIMINARY PREPARATION

Neckstrap and Case

Slide the scratch prevention ring and spare battery case which houses a spare battery onto the Canon AT-1's neckstrap, then thread the neckstrap through the rings. Adjust the neckstrap to a length most suitable for you.

Firmly attach the case to the camera by turning the screw on the bottom of the case. When you wish to take off the top cover of the soft case, turn the top cover to the bottom then slide it straight up in the direction of the arrow and pull it out as indicated in the photo.

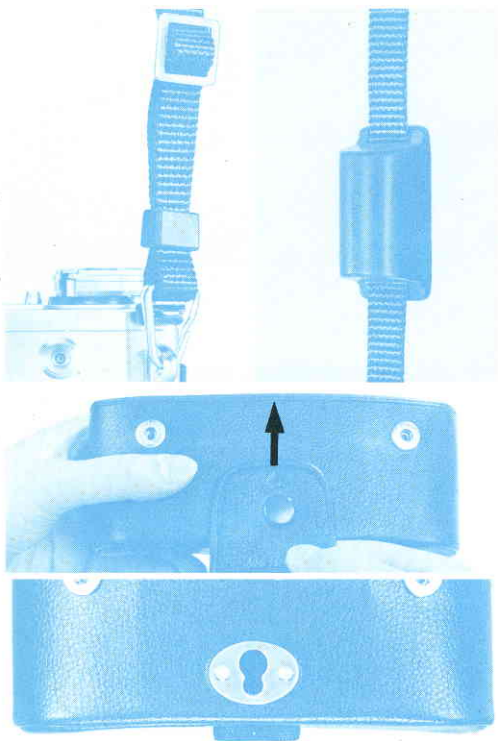

Handling the Lens Cap

The lens cap can be removed from the front of the lens after pressing in the tabs on both sides of the cap. The rear dust cap can be removed by turning the Canon Breech-Lock ring in the direction of the arrow. To attach the dust cap, align its slot with the positioning pin below the red dot of the Breech-Lock ring, and press it in. When the dust cap is removed, the Breech-Lock ring is locked.

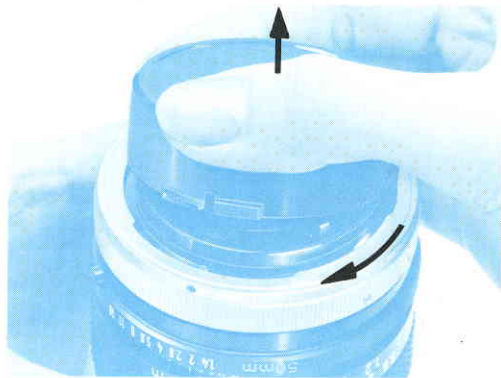

Mounting the Lens

Remove the body cap. Make sure that the aperture ring is not set to the "A" mark before mounting the lens. Release the aperture ring from the "A" mark by pushing the EE lock pin and turn the ring. Then, mount the lens by aligning the red dot of the body with the red dot of the bayonet ring, and then turning the Breech-Lock ring clockwise, pressing gently until it locks into position. Reverse the procedure to dismount the lens.

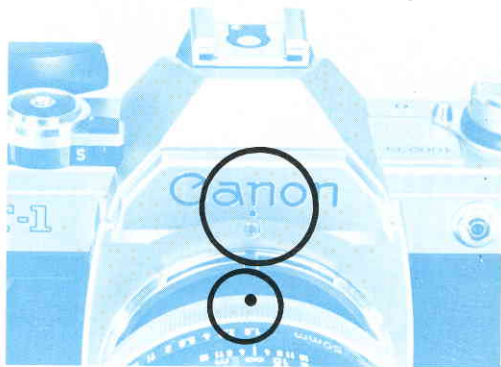

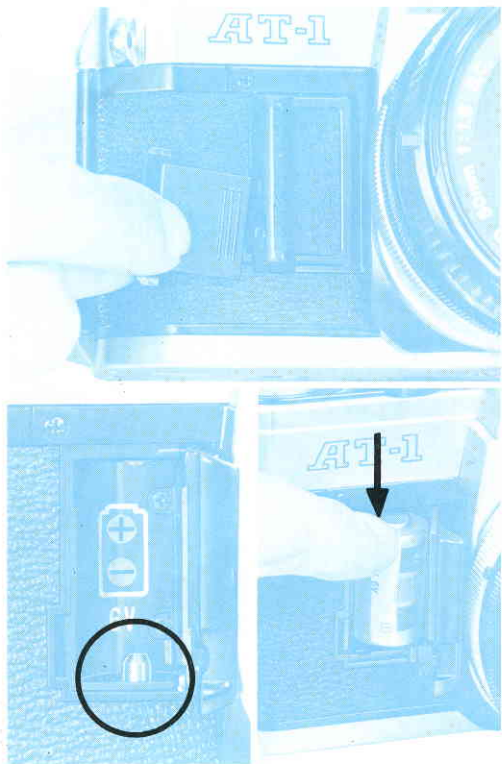

Loading the Battery

The camera will function only when the battery is loaded and the main switch is turned on. Use a silver oxide battery for the power source. The battery chamber cover can be opened more easily by using the viewfinder cover that is inserted into the accessory shoe.

Be careful to load the battery correctly with the "+" side up following the diagram on the inside of the battery chamber. If the battery is incorrectly loaded so the polarities are facing the wrong direction, the camera will not function. Load the battery by inserting the "-" contact first while holding down the battery in the bottom of the battery chamber. When loading or removing the battery, make certain that the main switch is set at OFF.

- Only a silver oxide battery can be used and other types cannot be used. In general use, the battery will last one year.

Main Switch

The main switch turns on or off the electric circuits of the camera. Therefore, when taking photographs, set the main switch to the "ON" position. The camera will not function unless it is set to "ON".

■ When not in use, turn the main switch to "OFF" to guard against needless consumption of the battery.

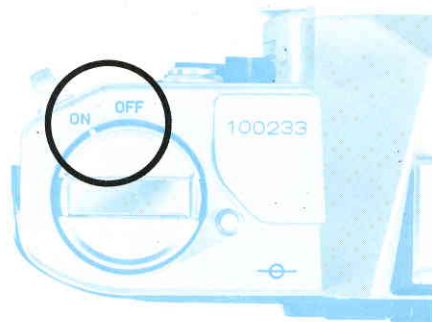

Usable Batteries	
Silver Oxide Battery(6V)	Eveready(UCAR) No.544 JIS 4G13, Mallory PX28

Perform a battery check in the following situations:

1. When a battery is loaded.
2. If the shutter does not function.
3. When a great number of photographs have been taken.
4. When the camera is used after it has been stored for a long period without use.
5. When the camera is used in extremely cold conditions.

As the AT-1 is an electronically controlled camera, the shutter will not function without sufficient battery power.



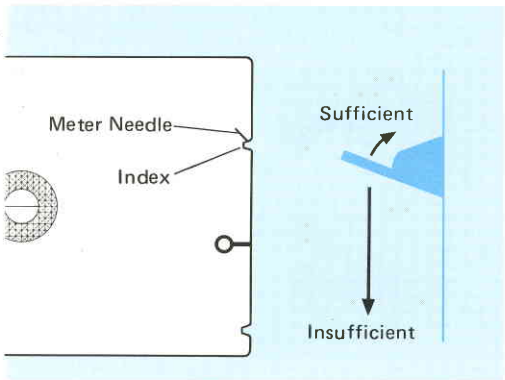
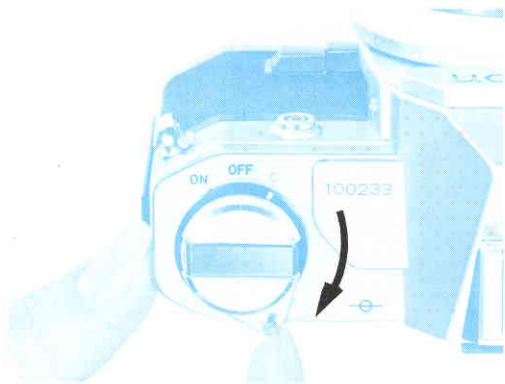

Checking the Battery

The main switch is also used for checking the battery. To see if the battery power level is sufficient, turn the main switch/battery check lever to the "C" index on the outer rim of the film rewind crank while looking into the viewfinder. When the meter needle rests above the battery check lower border, which is indicated by the meter needle position illustrated below, the power level of the battery is sufficient. If the meter needle just barely coincides with this lower border, the battery is near exhaustion and should be replaced. If the meter needle does not rise to the index, the battery must be changed.

Film Advance and Shutter Release

Turn the film advance lever until it stops, so the film will advance one frame all in one motion. The shutter will cock, and the diaphragm and mirror will be ready for the next shutter release, while the frame counter advances simultaneously to the next number. By pushing the film advance lever lightly with the tip of your thumb, it will open to its 30° stand-off position away from the camera body for easy film advance.

While the film is advancing, the shutter will not be released. Film winding can also be accomplished by advancing the lever in short strokes.

Canon has developed the Power Winder A to be used with the AT-1 for automatic film winding. It greatly increases the speed and mobility of the AT-1. (See page 62.)

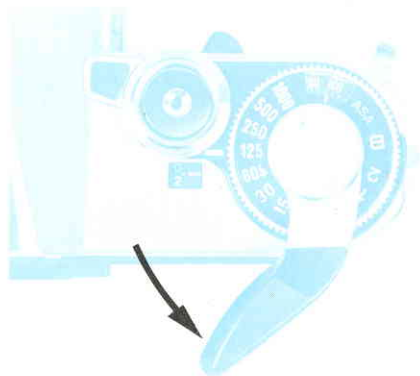

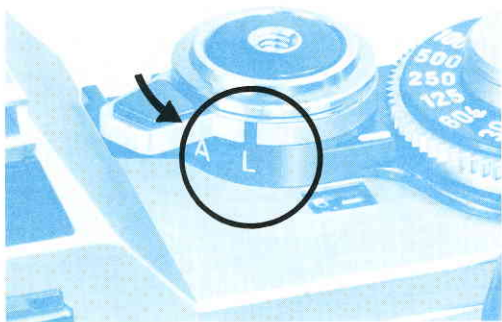

Shutter Button and Shutter Lock

The magnetic release shutter button enables smoother shutter release than the mechanical release method does. There is also less chance for camera shake.

When the shutter lock lever around the shutter release button is turned to the "L" position, the shutter button will be locked to prevent unintentional shutter release. Keep the shutter release button locked while carrying the camera to prevent film waste.

When the power level of the battery is insufficient, a safety mechanism will keep the shutter from being released.

- At temperatures under -20 degrees C, there may be an occurrence when the shutter will not be released depending on the batteries, even if the battery power is sufficient. In that cold condition, the battery's power is reduced so some 10 seconds should be allowed after the battery is checked before taking a picture.

Loading the Film

The Canon AT-1 uses color or black and white film in standard 35mm cartridges.

Opening the Back Cover

To load a cartridge of film into the camera, first open the camera's back cover. Pull up the rewind crank and the back cover will pop open. The back cover can be securely closed simply by pressing it until it locks. Avoid direct sunlight when loading or unloading the film.

The Canon Data Back A, an accessory for imprinting data such as the day, month and year, can be attached to the AT-1 in place of the back cover. (See page 63.)

How to Load the Film

Put the cartridge into the film cartridge chamber and press down while rotating the rewind knob until it drops securely into position. The protruding part of the cartridge should be on the bottom. Pull the film leader across and insert the end into one slot of the multi-slot take-up spool. Turn the film advance lever and wind the film around the

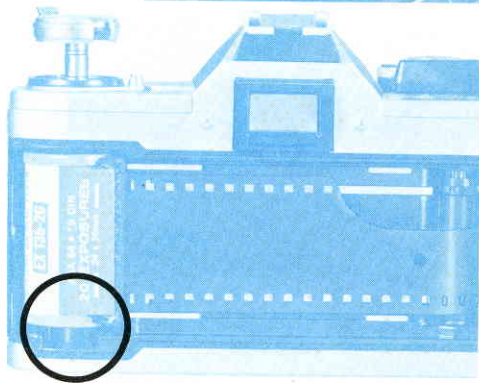
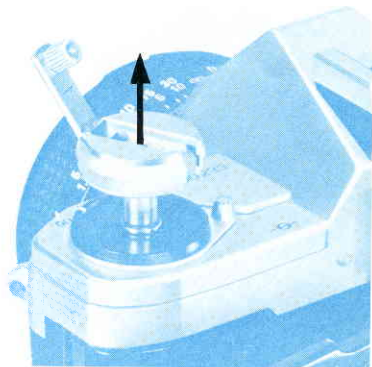

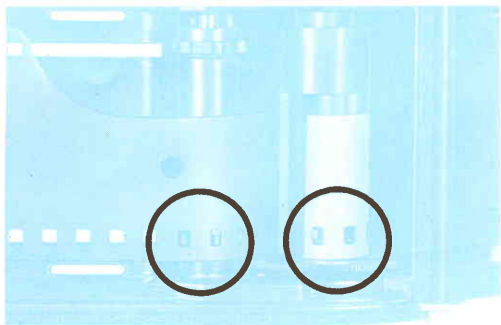

take-up spool making sure that the perforations of the film are engaged in the teeth of the film transport sprocket.

Then, make sure that there is no film slack. In case there is, gently turn the film rewind crank in the direction of the arrow to obtain proper film tautness and the film advance lever to ensure that the leader is wound fully on to the take-up spool before the camera back is closed.

When loading the film into the camera, do not touch the shutter curtain, the film rails or the pressure plate.

Closing the Back Cover

Close the back cover until it snaps shut. Gently turn the film rewind crank clockwise in the direction of the arrow to take up the film slack. Then, advance the film a couple of times pressing the shutter button until the first exposure appears in the frame counter.

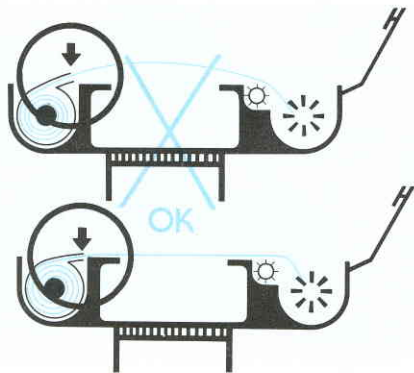

Frame Counter

The frame counter is an additive type which counts one frame every time the film advance lever winds the film. When the camera's back cover is opened, the frame counter automatically resets itself to the "S" position.

While rewinding film, the frame counter counts back the frame numbers. The starting position "S", 0, and the even numbers 2 to 38 are displayed by the counter. Numbers 20 and 36 are marked in orange to call your attention to the end of commercially available film cartridges. The frame counter cannot count higher than 38.

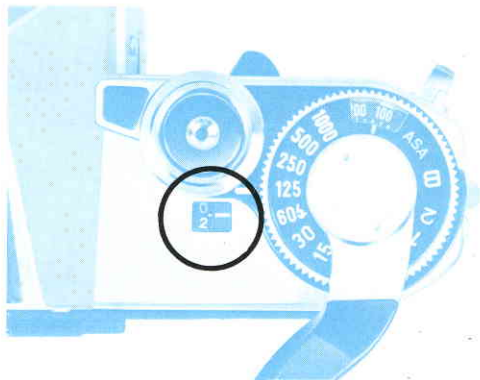

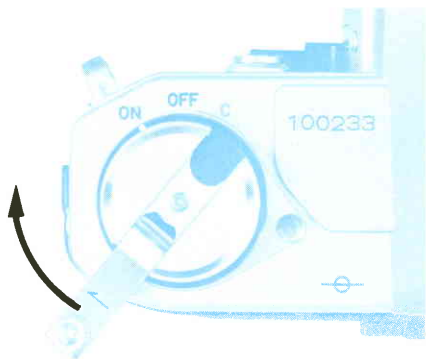

Checking Film Winding

Operate the film advance lever while watching the film rewind knob. If it rotates, the film is properly loaded. If the rewind knob does not rotate, open the back cover and load the film again from the start.

Setting the ASA Film Speed

After loading the film, set the ASA film speed according to the ASA speed of the film in use. To set the ASA, first push the film advance lever out to its 30° stand-off position away from the camera body, then gently lift up the ASA ring around the shutter dial and rotate it in either direction until the proper number is aligned with the green index mark. ASA is a numerical rating of a film's sensitivity to light. A higher ASA number indicates a faster film which is more sensitive to light. On the other hand, a lower ASA number indicates a slower film which is less sensitive to light. The ASA rating recommended by the manufacturer is printed on the film box, e.g., ASA 100.

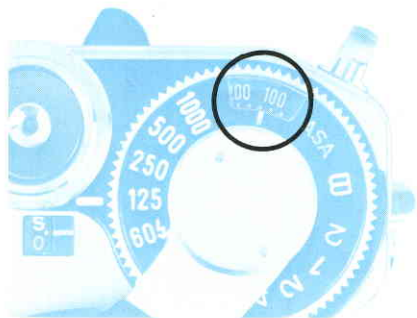

The following ASA ratings can be set on the camera. Figures in parentheses indicate intermediate film speeds.

ASA 25 (32) (40) 50 (64) (80) 100 (125) (160) 200 (250) (320) 400
(500) (640) 800 (1000) (1250) 1600 (2000) (2500) 3200

Use of the Memo Holder

The memo holder on the camera's back cover is useful for keeping data like film speed, location, shooting. For example, after tearing off the part of the film box which specifies the type of the film being used, it can be inserted into the memo holder as a constant reminder.



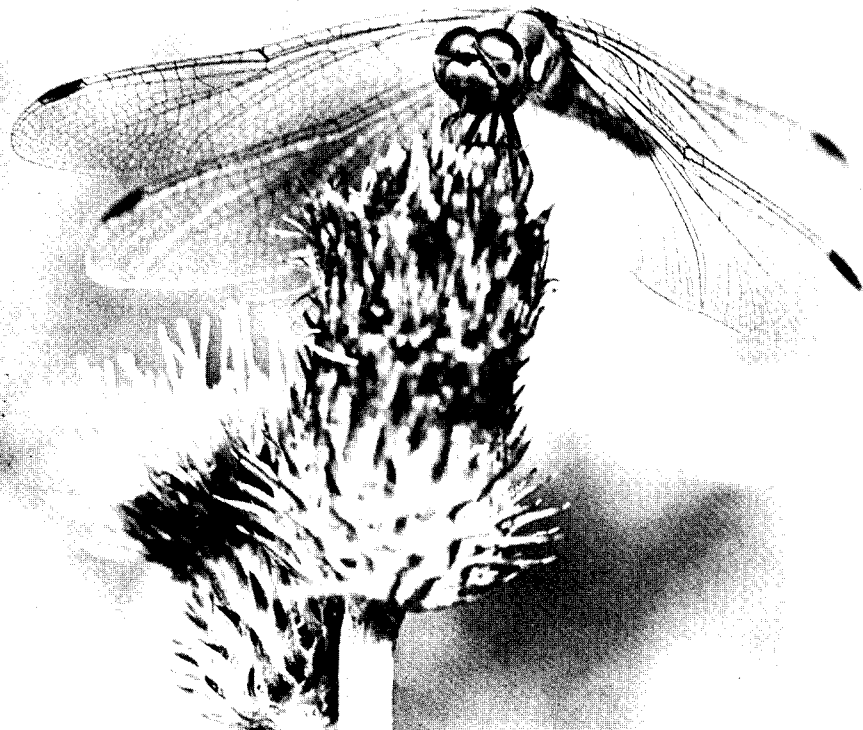

Operation for General Photography



Shutter and Aperture

The opening of the shutter letting light in on the film is called an exposure. The amount of light striking the film is controlled by the lens aperture, while the length of time that light is allowed to strike the film is controlled by the shutter.

Shutter Speed Dial

The shutter dial is used to adjust the shutter speed. It allows for speed settings in the range of 2 seconds to 1/1000 of a second. When the shutter speed is advanced to the next larger number, the exposure time is cut in half. The shutter speeds on the dial are typically the reciprocals of the true shutter speeds. For example, 125 and 250 on the dial represent shutter speeds of 1/125 and 1/250 of a second. Only in the case of the orange "2" is the shutter speed actually as indicated on the dial, i.e., 2 seconds. The "B" (Bulb) setting is used for long exposures where as long as the shutter button is pressed down, the shutter will remain open.

- The shutter speed dial cannot be set to an intermediate position.

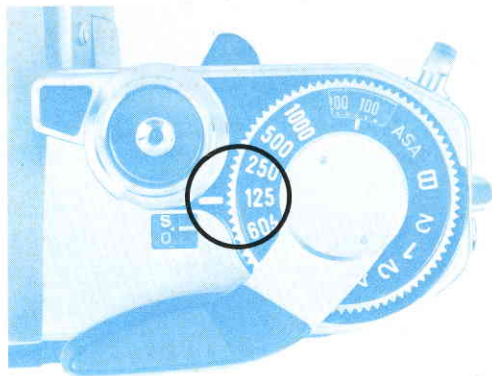

Brightness	Shutter Speed (Seconds)
Indoors	1/30 to 1/60
Outdoors	1/125 to 1/250
Mid-summer Beach or Snow-covered Mountains	1/500 to 1/1000

Selecting the Shutter Speed

Shutter speed is determined in accordance with the brightness of the scene and the speed with which the main subject is moving. You can use the above table as a general guide

to help you select an appropriate shutter speed when using a standard 50mm lens. For indoor photography, with no special illumination, choose 1/30 of a second and 1/60 of a second in a brightly lit room.

For outdoor photography, select 1/125 second when cloudy and 1/250 second in sunshine. To take pictures in particularly bright sunshine such as at a beach in mid-summer or in snow-covered mountains, use shutter speeds of 1/500 sec. or 1/1000 sec.

The above mentioned shutter speeds apply when using a standard 50mm lens, but it is necessary to choose faster shutter speeds when using lenses of longer focal lengths because they are more difficult to hold steady. It is generally said that the shutter speed figure should be greater than 1 divided by the focal length of the lens in order to obtain sharp images.

For example, when using a 200mm telephoto lens, shutter speed should be faster than 1/200 second. Therefore, the shutter speed in this particular case should be set at 1/250 sec. Image blur can also arise if the camera is not properly held. See page 37.

Lens Aperture

The adjustment of the aperture is used with the shutter speed to get the correct exposure. The amount of light reaching the film is controlled by the aperture's size.

On the aperture ring are a series of markings which indicate the proportion of the light allowed to pass through the lens, which are known as f/numbers. When the aperture ring is set to the next larger f/number on the scale of the ring, the amount of light passing through the lens is decreased by 1/2. The lens's brightness is based on the smallest numerical aperture value for the lens. With a f/2 serving as the standard, the comparative brightness at each f/stop will be as indicated below.

Brightness (f/stop)	1.2	1.4	2	2.8	4	5.6	8	11	16
Ratio	3	2	1	1/2	1/4	1/8	1/16	1/22	1/64

The aperture ring can be set at positions between the settings on the scale.

Viewing and Focusing

Focusing is performed in the small round area in the center of the viewfinder. The smaller central circle is a split-image focusing screen and around it is the microprism ring. The split-image rangefinder ascertains that the image is "in focus" when the image divided horizontally in half merges and becomes one complete image.

The microprism rangefinder presents a clear and steady image when in focus. The microprism conveys a broken, shimmering image when not accurately in focus. It is also possible to focus with the matte screen outside the smaller central area. You can focus with any of these focusing aids as you like, depending on the subject and your preference.

Accessories such as an eyecup, dioptic adjustment lenses, angle finders, and magnifier can be attached to the viewfinder eyepiece.

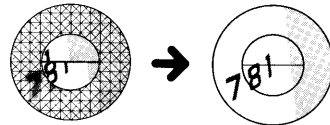
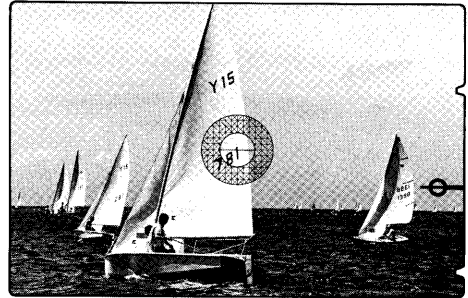

Out of Focus

In Focus

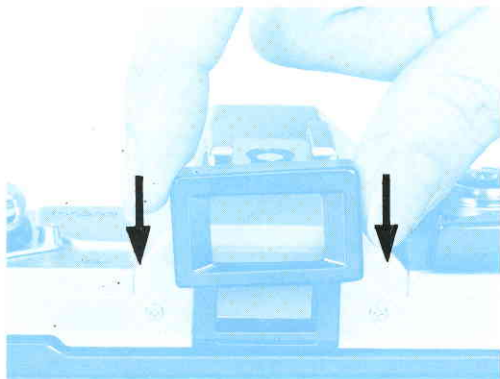

Dioptric Adjustment Lens S

Dioptric adjustment lenses can be attached by inserting them from above into the grooves in the viewfinder eyepiece to compensate for the individual eyesight. With them, near-sighted or far-sighted persons can perform photography without glasses.

The built-in eyepiece lens of the AT-1 has -1 diopter. The following 10 kinds of dioptric adjustment lenses are optional accessories: $+3$, $+2$, $+1.5$, $+1$, $+0.5$, 0 , -0.5 , -2 , -3 and -4 (diopters).

One way of selecting the correct dioptric adjustment lens for you is to select the one that is the closest to your glasses in regard to number of diopters. But, we propose that, to select the most appropriate dioptric adjustment lens, you actually look through the viewfinder after placing it over the eyepiece.

Because the camera itself has -1 diopter, the diopters of the lenses are recorded as the real power when attached to the camera, thus reflecting the power of the camera's viewfinder.

Angle Finder A2 and B

The angle finder slips over the viewfinder eyepiece. It rotates 90 degrees so that the image on the viewfinder can be viewed directly from the side or above whenever it is inconvenient or impossible to look directly through the eyepiece. This is very helpful in copying, close-ups, macrophotography, and photomicrography. There are two types, the A2 whose image is reversed as in a mirror, and the more advanced Angle Finder B which gives a correct image.



Magnifier S

The Canon Magnifier S gives 2.5X magnification of the viewfinder center for precision focusing in close-up work. The power can be adjusted to your eyesight within the range of +4 to -4 diopters.

The Magnifier S combined with its adapter can be inserted into the grooves of the viewfinder eyepiece. The adapter of the Magnifier S is hinged to allow the magnifier to swing upward from the eyepiece leaving the whole screen image visible after focusing.

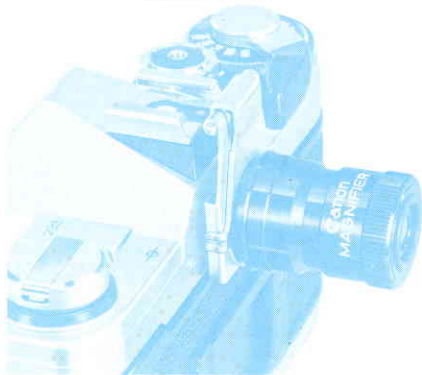

Viewfinder Information

The Canon AT-1 is a camera offering full aperture metering with FD lenses where the aperture needle is coupled to the shutter speed, aperture and film's sensitivity when FD lenses are used. Furthermore, when using Canon FL lenses on the AT-1, the exposure reading is performed with stopped-down metering.

The Central Emphasis Metering method of exposure measurement is used in the AT-1 to deliver the optimum exposure to the main subject without being affected by the bright sky in the upper part of the picture area.

In the center of the viewfinder is a range-finder while the meter needle and the aperture needle (circular) are found to the right. The exposure metering range index marks are in the upper and lower right. The exposure metering range index mark in the upper right is also used as the battery check index mark. The exposure metering range extends from EV 3 (f/1.4, 1/4 of a second) to EV 17 (f/16, 1/500 of a second) at ASA 100 film with FD 50mm f/1.4 S.S.C. lens.

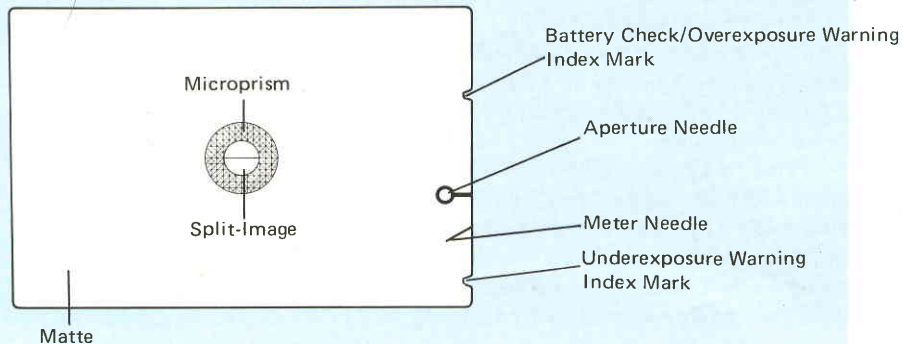

Determining the Exposure

Turn the camera toward the subject and look into the viewfinder to insure that the meter needle swings and rests still somewhere between the upper and lower exposure metering index marks. Then, turn the shutter speed dial and/or the aperture ring until the circular aperture needle bisects the meter needle. These are the steps for getting the correct exposure. On most occasions, it is more convenient to predetermine the shutter speed then turn the aperture ring.

The upper and lower halves each express half an f/stop gradation; the full width of the

aperture needle is equivalent to one f/stop. Thus, the setting of the meter needle and aperture needle can be precisely controlled inside the viewfinder enabling finer adjustment of the exposure.

■ Exposure determination (matching needles) should not be performed while the shutter button is depressed. It will cause a slight, variable error depending on the condition of the battery.

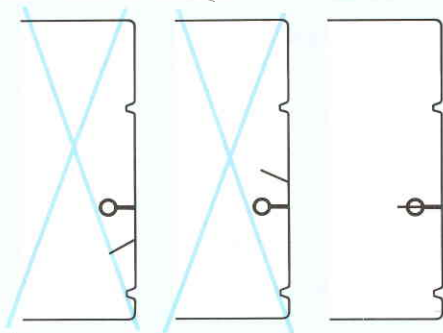

Properly Adjusted

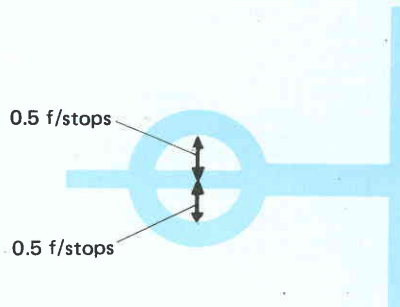

Operation of Shutter Priority

1. Turn the main switch on.
2. Set the shutter speed.
3. Look into the viewfinder and focus.
4. Turn the aperture ring and align the meter needle with the aperture needle.
5. Depress the shutter button.

Exposure Metering With FL Lenses

When Canon FL lenses are used on the AT-1, it is necessary to take a stopped-down meter reading. After pressing in the stopped-down lever until it locks, adjust the aperture ring and/or shutter speed dial until the meter needle inside the viewfinder is aligned with the aperture needle to obtain the correct exposure. After determining the correct exposure, release the stopped-down lever and compose and focus at maximum aperture.

Meter Coupling Range

If the circular aperture needle does not align with the meter needle by turning the aperture ring, it means that the shutter speed is not properly set. If this is the case, reset shutter speed dial so that two needles can be aligned with each other. And when these two needles cannot be aligned with each other by turning the shutter speed dial, change the aperture. When the shutter speed is set at a slow speed outside the meter coupling range, metering cannot be performed even if the aperture is changed.

The built-in exposure meter couples to the range of the aperture and shutter speed with respect to the film speed. For example, when using the FD 50mm f/1.4 S.S.C. lens and ASA 100 film, the exposure meter couples within the range of from EV 3 (f/1.4 at 1/4 sec.) to EV 17 (f/16 at 1/500 sec.).

Film Speed	Shutter Speed											
	1	1/2	1/4	1/8	1/15	1/30	1/60	1/125	1/250	1/500	1/1000	
ASA 25	1	1/2	1/4	1/8	1/15	1/30	1/60	1/125	1/250	1/500	1/1000	
ASA 50	1/2	1/4	1/8	1/15	1/30	1/60	1/125	1/250	1/500	1/1000	...	
ASA 100	1/4	1/8	1/15	1/30	1/60	1/125	1/250	1/500	1/1000	
ASA 200	1/8	1/15	1/30	1/60	1/125	1/250	1/500	1/1000	
ASA 400	1/15	1/30	1/60	1/125	1/250	1/500	1/1000	
ASA 800	1/30	1/60	1/125	1/250	1/500	1/1000	
ASA 1600	1/60	1/125	1/250	1/500	1/1000	
ASA 3200	1/125	1/250	1/500	1/1000	
Minimum f/stop	f/22	f/22	f/22	f/22	f/22	f/22	f/22	f/16	f/11	f/8	f/5.6	



Holding the Camera

The electromagnetic shutter release button has a short, soft touch. The shutter can be released by lightly depressing the shutter button to help prevent camera shake. But, unsteady holding of the camera will cause camera shake in spite of the electromagnetic shutter release system.

Therefore, be sure to hold the camera firmly. Rest the camera on your left palm and grasp the lower part of the lens focusing ring between your thumb and forefinger or middle finger. Hold the right end of the camera firmly, with your right thumb behind the tip of the film advance lever and your right forefinger on the shutter button, while the other fingers hold the camera's finger grip.

To reduce camera shake, press your left elbow strongly against your body and look into the viewfinder steadying the camera against the forehead. The right arm should be relaxed while holding the camera.

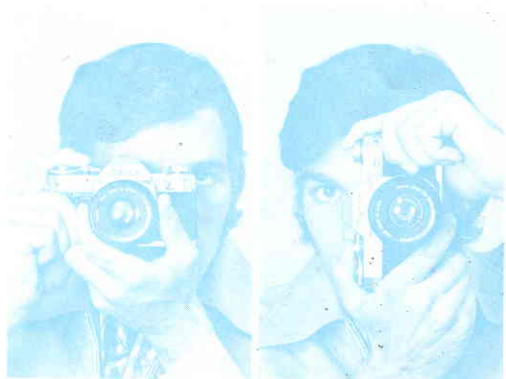

When you use comparatively slow shutter speeds or when you use telephoto lenses, it is advisable to lean against a wall, a tree trunk or some fixed object for a steadier grip. The above describes the fundamentals of how to hold the camera. You may find yourself the most appropriate grip for you and get accustomed to it through constant practice.

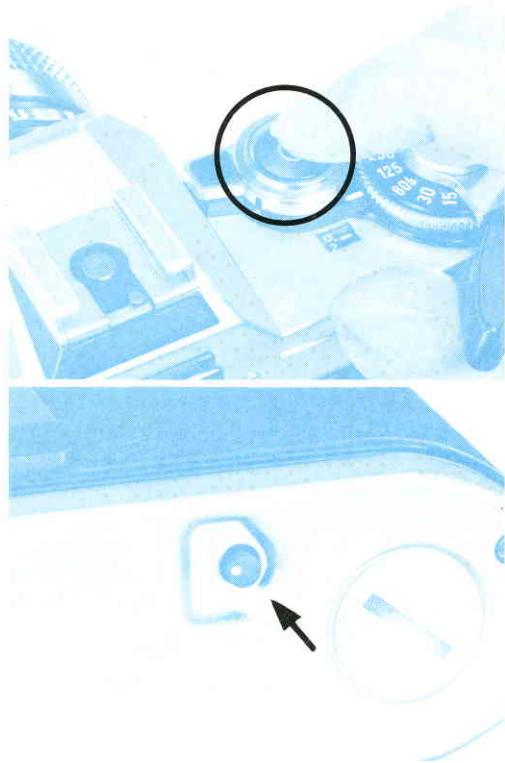

Releasing the Shutter

When you press the shutter button, try to squeeze the shutter button gently with your finger. Avoid hitting or pressing the shutter button suddenly particularly when using slow shutter speeds, otherwise blur may result.

At the moment of shooting, you should exhale slowly while the shutter button is being pressed.

Rewinding the Film

When the film advance lever cannot travel all the way to the end of its stroke, the frame counter tells you that you have reached the end of the film. You have to rewind the film in its protective cartridge, before you can remove it from the camera. Since it is not protected, any exposure to light will “fog” the film and cause a drastic color shift and loss of image.

To rewind the film, press in the small rewind button on the bottom of the camera,

unfold the rewind crank and turn it in the direction of the arrow on the rewind crank. When the frame counter has reached the "S" mark, you should stop rewinding. Then pull up the rewind knob to open the camera back and lift the cartridge out.

If you stop rewinding the moment the frame counter has reached the "S" mark, the film will not be completely rewound into the cartridge and the film leader will still be outside the cartridge.



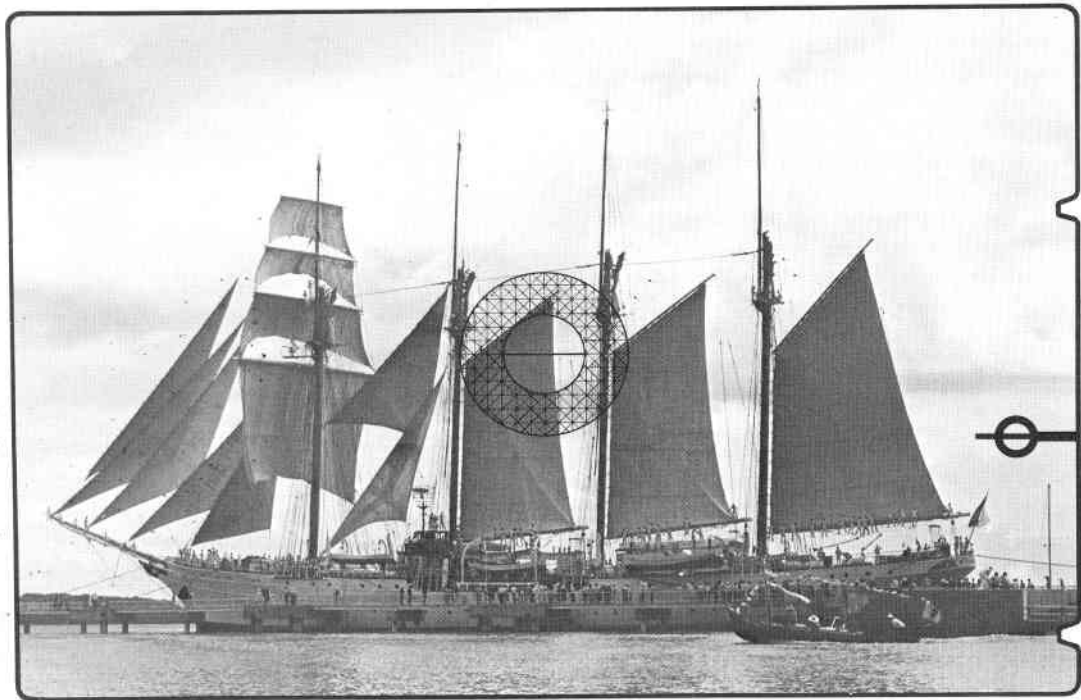

Detailed Operation of the AT-1



Concerning the Exposure (Shutter Speed and Aperture Coupling)

In order to obtain the correct exposure, it is necessary to correctly match the shutter speed with the aperture. The shutter speed and the aperture are the main factors in controlling the amount of light which is allowed to strike the film, and when they change, the quality of the image upon the film also changes.

Effects of Changing the Shutter Speed

The explanations below are pertinent to photography with fast moving subjects or when it is intended to produce impressionistic pictures of movement. Depending on the selection of the shutter speed, you can freely control the expression of movement.

If, as in example A, the photo is taken at a shutter speed of $1/1000$ sec., the movement will be frozen. If, as in example B, with the same subject, the photo is taken at a shutter speed of $1/60$ sec. with a panning technique, the movement is well expressed.

Panning is really quite a simple technique. Hold the camera firmly and continue twisting the upper part of your body while following





the moving main subject in the viewfinder. You then release the shutter while still twisting. When you use this technique, the main subject should be sharp even at slow shutter speeds and the image of the background is blurred according to the speed of the panning movement. This heightens the feeling of motion in the picture.

Effects of Changing the Aperture

The lens aperture does not only control exposure but it also has an effect on the photograph as follows:

In example C, the aperture was set at $f/5.6$ with the shutter speed dial adjusted before shooting. In example D, a $f/16$ setting was used to clearly demonstrate the difference. In C, the miniature cars in the back and front are blurred and only the miniature cars in the central area are in focus. In D, most of the miniature cars are sharp and clear. Thus, the lens aperture has a marked effect on how much of the picture is reproduced sharply.

Depth-of-Field

When a certain subject is brought into focus, there is only a limited range in the foreground and background of the subject which can be kept clearly in focus. This zone of sharpness is the depth-of-field.

There are two methods of confirming the extent of the depth of the field: by stopping down the lens diaphragm or by reading the depth-of-field scale on the lens.

Confirming the Depth-of-Field by Stopping-Down the Lens Diaphragm

Press the stopped-down lever until it locks. Once locked, the depth-of-field can be checked by looking into the viewfinder. Thus, the extent of the depth-of-field can be seen as the zone of sharpness in the subject field observed on the screen. When the stopped-down lever's release button is pressed, full aperture metering will be restored.

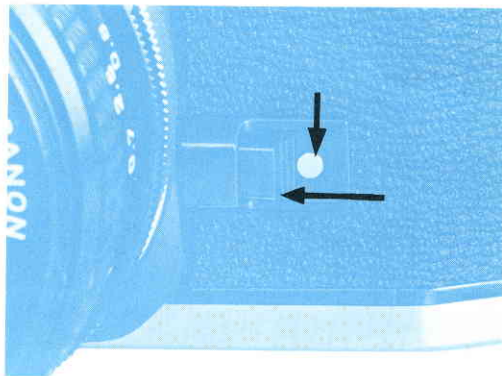

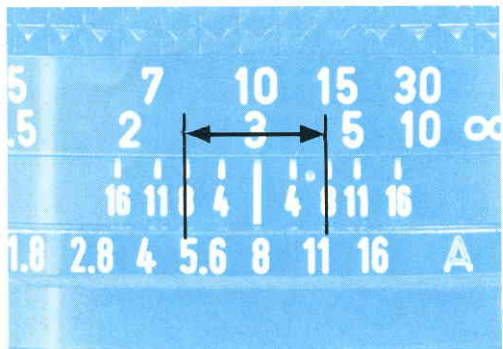

Generally, the depth-of-field will become deeper as the aperture becomes smaller, and shallower as the aperture becomes larger. A shorter focal length as well as a greater camera-to-subject distance will also deepen the depth-of-field.

Comparing a 28mm lens with a standard 50mm lens set at the same f/stop, the 28mm lens's depth-of-field will be greater. And when the photographic distance changes, the depth-of-field changes, too. For example, if the same subject is photographed from three and then from seven meters away, the sharp foreground

and background of the subject will be deeper at the greater distance.

Depth-of-Field Scale on the Lens

A depth-of-field scale is engraved on the lens barrel, shown as a series of f/numbers on each side of the distance index mark opposite the distance scale. Focusing and depth-of-field are so closely interrelated that the depth-of-field scale is engraved together with the distance scale.

You can tell the extent of depth-of-field from the distance scale. For example, if you use the camera with a standard 50mm lens that is focused on a subject at medium distance, say 3m with the aperture set at f/8, the depth-of-field extends from 2.4m to 4.5m. This tells you that with the 50mm lens focused at 3m and the subject between 2.4m and 4.5m the film image will be reasonably sharp.

Using the Self-Timer

Obvious uses for the self-timer are self-portraits and the inclusion of the photographer in a souvenir picture. The self-timer can also be used in place of a cable release to release the shutter gently and smoothly in close range work like photomicrography or copying.

Push the electronic self-timer lever forward, then press the shutter button, and the shutter will be released 10 seconds later. While the self-timer is in operation, the self-timer lamp flashes on and off. After you finish taking a picture, the self-timer lever should be reset to its original position. Otherwise, it will function again the next time you press the shutter button.

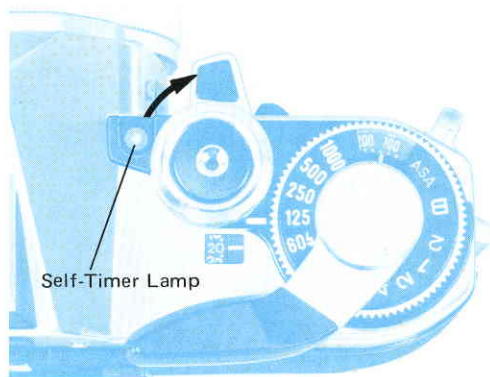

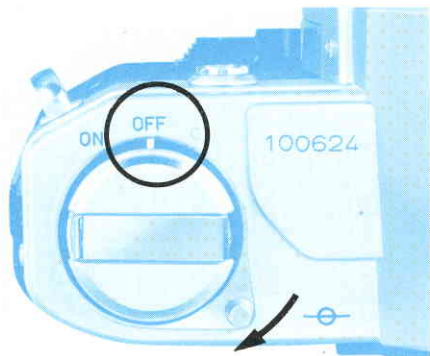

Canceling the Self-Timer Operation

If you should want to cancel the self-timer operation after having pressed the shutter button, set the main switch to OFF on the top side of the camera. Then, the self-timer lamp stops blinking and the self-timer operation will be cancelled. If the main switch is not set to OFF and the self-timer lever is returned to its original position, the shutter will be released.

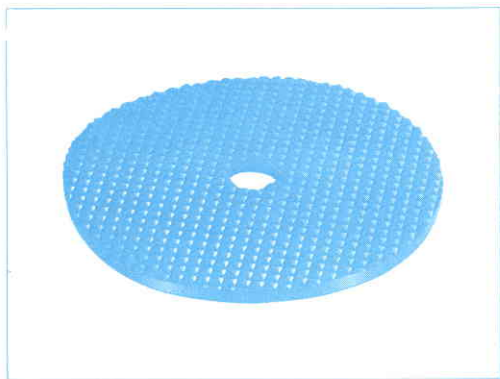

Adapter A for Tripod

When using a great diameter lens, depending on the tripod being used, it may be difficult to hold the adjustment in the case of accidental bumping of the lens. In such cases, the rubber Adapter A for Tripod may be placed between the tripod head and the camera.

Flash Photography with the AT-1

The Canon AT-1 can be used with two different type of flash units; a directly coupled contact type and a synchronization cord type. Use the Canon Speedlite 155A or 199A of a directly coupled contact type for exceptional flash photography.

When using a flash bulb or an electronic flash other than the Speedlite 155A and 199A, you can select the appropriate shutter speed in reference to the table of "Flash Synchronization Range" indicated below.



Flash Synchronization Range

Type		Synchronized Shutter Speed	1/1000	1/500	1/250	1/125	1/60	1/30	1/15	1/8	1/4	1/2	1	2	B
		Flash Bulbs	FP Class							△	○	○	○	○	○
M and MF Class								△	○	○	○	○	○	○	○
Electronic Flash							○	○	○	○	○	○	○	○	○

(△ mark indicates possible unevenness in the picture depending on the flash bulb.)

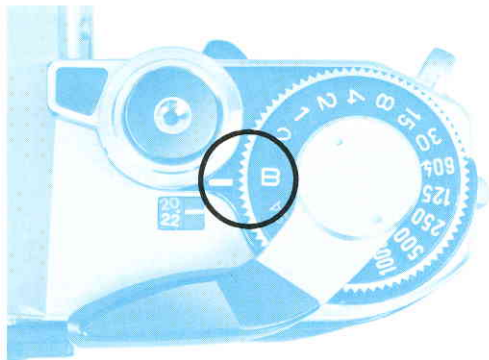

Long Exposures and “B” (Bulb) Setting

When you need shutter speeds slower than two seconds such as for shooting night scenes or fireworks, set the shutter speed dial at “B”. Then, the shutter will remain open as long as the shutter button is pressed. In long exposures, it becomes essential to mount the camera on a tripod and use a cable release preferably with a lock to prevent camera shake and attain best results.

A cable release with a locking device can keep the shutter open even though the operator leaves the cable release unattended. Unlock the cable release to close the shutter.

Photography using the “B” setting will accelerate battery consumption since it requires continuous battery power. When necessary, the battery should be replaced with a new one having a full charge.

Film Plane Indicator

This mark is engraved on the top of the camera beside the film rewind crank, just to the left of the pentaprism, to indicate the exact position of the film plane. The distance scale on the lens shows subject distances measured from the film plane indicator. This mark is not used in general photography, but in close-ups and macrophotography it can be used to obtain the exact film-to-subject distance.

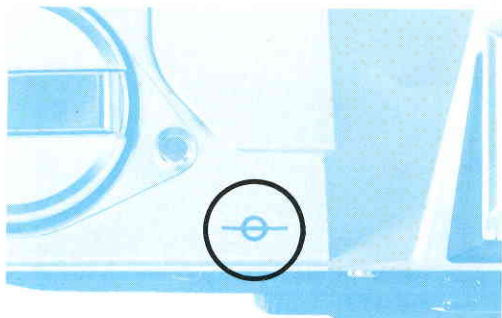

Stopped-Down Metering

When the AT-1 is used with Canon FD lenses, photography can be performed with match needle type full aperture metering. Even when the lens automatic aperture lever is locked in the manual position, FD lenses should not be used on the AT-1 with stopped-down metering. This will cause improper meter readings.

In spite of this, in those cases of the Canon FL lenses and most accessories such as bellows, extension tubes, or a microscope adapter, you must take a stopped-down meter reading. Stopped-down metering is performed by pushing the stopped-down lever until it locks with the main switch at ON, and adjusting the shutter dial and/or the aperture ring until the meter needle is aligned with the aperture needle. Press the shutter button and the photograph will be perfectly exposed.

If the lens should be mounted on the camera with the stopped-down lever locked, correct exposure will not be obtained. In this case, a red warning mark by the stopped-down coupling lever inside the camera body is visible. After removing the lens, on the lower part of the camera body, just below the

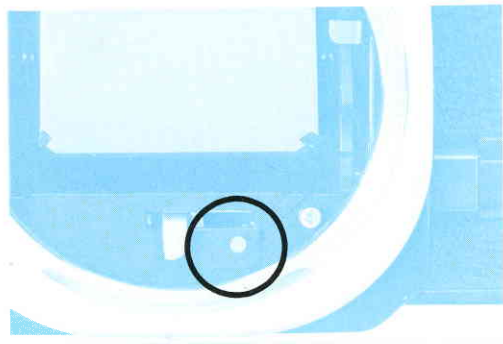

mirror, this stopped-down coupling lever becomes visible, as does the red mark in the case described above.

The Extension Tube FD 25 and FD 50 especially designed each for the FD 50mm and FD 100mm macro lenses should be used with full aperture metering. In this case, depth of the field can be assured in the viewfinder by pressing in the stopped-down lever.

Manual Diaphragm Control

When accessories requiring manual diaphragm control are used between the camera body and a lens, lock the lens automatic aperture lever in the manual position before mounting the lens.

Lock for Manual Diaphragm Control (1)

For manual diaphragm control, push the automatic aperture lever counterclockwise until it stops and locks. When accessories such as extension tubes are attached to a lens that has been set for manual control, the diaphragm blades of the lens open or close as the aperture ring is turned. To revert from manual control, reset the automatic aperture lever to its original position.

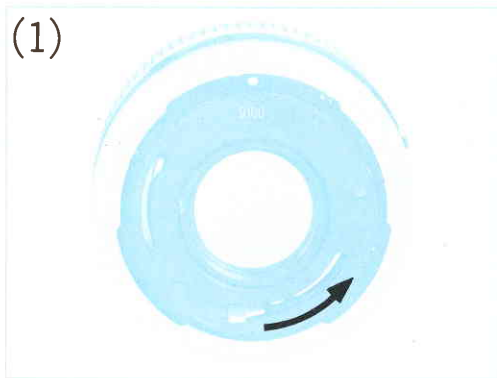

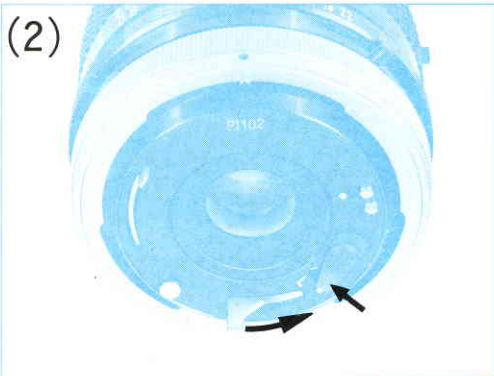

Lock for Manual Diaphragm Control (2)

There are some FD lenses with the manual lock lever requiring a different procedure for manual control setting. With these particular lenses, the automatic aperture lever must be turned fully counterclockwise while the manual lock lever is brought to the "L" position. Once this has been done, when the lens is mounted on the camera, the diaphragm blades will open or close by turning the aperture ring. To revert from manual diaphragm control, reset the manual lock lever at the position of the white dot.

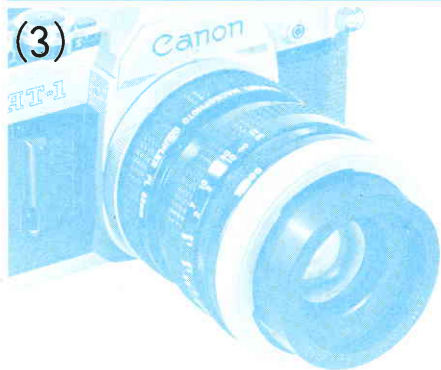

Lock for Manual Diaphragm Control When Using the Macrophoto Coupler (3)

In close-up photography of high magnification with a lens reversed on the Macrophoto Coupler, the automatic diaphragm mechanism is not coupled. you must, therefore, remember to close down the diaphragm manually after having locked the automatic aperture lever in the manual position as explained above in (1) and (2). Then, fix the Macrophoto Hood on the lens mount by turning the bayonet ring.

Changing the Lens

FD lenses incorporate a safety mechanism to prevent the Breech-Lock ring and the diaphragm blades from moving when the lens is not mounted on the camera. To bypass this safety mechanism, press the lock pin in the top recess of the Breech-Lock mount while turning the Breech-Lock ring. Once this safety mechanism has thus been cancelled, you can see the diaphragm blades move when activated by the automatic aperture lever.

Since FD lenses have signal pins and levers which couple with the camera body, special care must be taken not to damage them. One basic precaution is to always put the lens down facing down whenever you must change lenses.

Take notice that the following lenses cannot be used on the AT-1 due to interference with the body signal pins. Using these lenses will cause improper meter readings and may cause damage to the camera.

FL 19mm	f/3.5	R	50mm	f/1.8
FL 50mm	f/1.8	R	58mm	f/1.2
FL 58mm	f/1.2	R	100mm	f/2
R 35mm	f/2.5	R	100mm	f/3.5

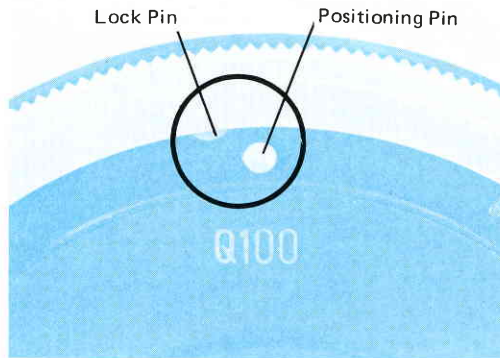

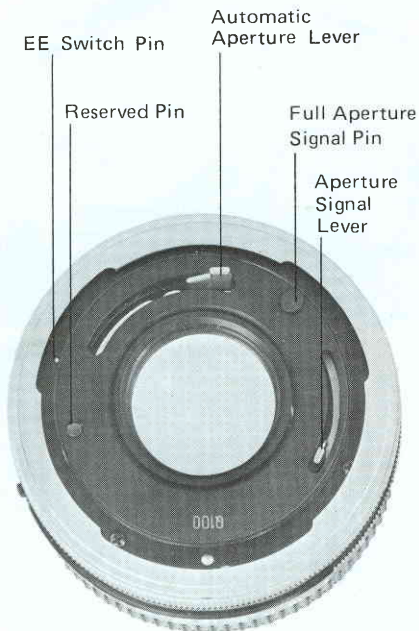

Lens Signal Coupling

Aperture Signal Lever

This lever transmits the actual f/stop to the exposure meter. It is coupled to the aperture ring.

Full Aperture Signal Pin

This pin transmits a signal indicating the maximum aperture of the lens.

Automatic Aperture Lever

This lever closes down the aperture. It couples with the stopped-down coupling lever.

EE Switch Pin

This pin protrudes when the aperture ring is set at the "A" mark. In this position, it transmits a signal for AE photography. When the aperture ring is set at the "A" mark, the lens can be attached only to the Canon EF, AE-1, and the F-1 equipped with the Servo EE Finder. If the lens is attached to the AT-1, it cannot be set at the "A" mark.

Reserved Pin

This pin is designed for use with accessories that may be developed in the future.

Distance Scale

The distance scale is for distances measured from the film plane. This scale is not generally used except for confirming the depth-of-field, performing guide number calculations in flash photography, or photographing with infrared film.

Read one-digit distances in the middle of the number marked on the scale. Two-digit distances should be read at the point in the middle of the two digits.

Depth-of-Field Scale

You can determine the depth-of-field by checking the depth-of-field scale and the distance scale on the lens barrel. Both are closely interrelated.

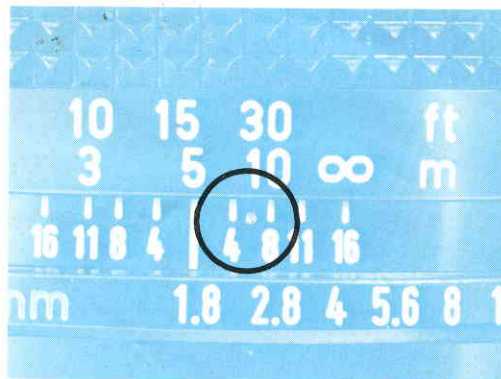

Infrared Index Mark

The red dot infrared index mark engraved on the lens barrel is a focusing correction index mark for infrared film. Because infrared light rays have longer wavelengths, they focus on a plane slightly behind that of ordinary visible light rays. Therefore, it is necessary to slightly modify the normal method of focusing the lens. After focusing the same as usual, note the tiny red dot engraved on the lens barrel just to the right of the distance index and turn the focusing ring slightly to align the focused distance with this red dot. For

instance normally, when the focus is adjusted at 5m on the distance scale, you turn the focusing ring slightly so that the 5 on the distance scale matches the red dot infrared index mark.

When photographing with infrared black and white film, visible light rays must be kept out by means of a deep red filter (R1) over the lens. The position of the infrared index mark is fixed for infrared film most sensitive to the $800\text{m}\mu$ wavelength and use of a red filter. For example, the Kodak Film IR 135 and the Wratten Filter 87.

When performing infrared color photography, follow the directions of the specific instructions of the film manufacturer.

Accessories, Care of the Camera, Maintenance and Miscellanea



Canon Speedlite 155A and 199A

When the Speedlite 155A or 199A is used with the AT-1, it is not necessary to set the shutter speed on the camera as is the case with ordinary electronic flash units. At any shutter speed except "B", the shutter speed is automatically adjusted to the X synchronization speed of 1/60 sec. at the time the flash is charged. To perform automatic flash photography, set the prescribed f/stops on the lens manually.

The Speedlite 199A is a powerful flash unit with a guide number of 30 (meters, with ASA 100 film). To control depth of field, you can choose between three auto working apertures which are automatically controlled to provide a right exposure to the main subject. The 199A also has bounce flash capability and, when used with the wide angle adapter, covers a 24mm lens field.

Both of flashes employ a unique light sensing system, so excessive reflection from the central area is reduced giving better overall exposure.





Canon Power Winder A

The Canon Power Winder A is an automatic film winder. It can be attached to any Canon AT-1 directly, without any other accessory or attachment. When you attach the Power Winder A to the Canon AT-1 and press the shutter button, the film will be immediately wound after being exposed. Furthermore, with the Power Winder A you can catch subjects' movements and changing expressions because you are able to take continuous or single frame photography at your pleasure. Continuous photography at up to two frames per second is performed just by keeping the camera's shutter button depressed. Shutter speeds from 1/60 to 1/1000 seconds couple in continuous photography. While in single frame photography, any shutter speed can be used. This is simply done by lifting your finger off the camera's shutter button.

The Canon AT-1 and Power Winder A form a compact, lightweight package that is as portable as a manual advance camera, and much more convenient.

Data Back A

This is an interchangeable back cover with a built-in data imprinting mechanism. It can imprint the day, month and year on the lower right hand corner of the photograph at the moment of the shutter's release, as well as other data to identify or classify the pictures you take. It imprints letters of the alphabet and Roman numerals for greater versatility and convenience.

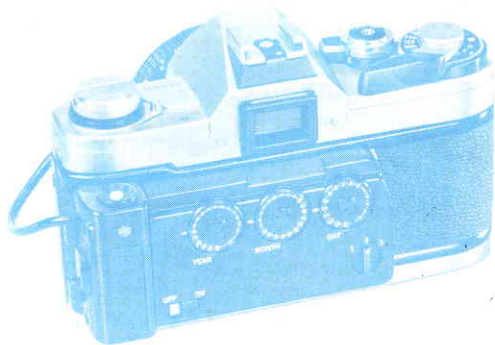

Auto Bellows

The Canon Auto Bellows is a sophisticated bellows for use with any Canon single-lens reflex camera. Automatic diaphragm coupling is possible with the Auto Bellows when the Canon Double Cable Release is jointly used. The Auto Bellows is considered the true center of Canon photomacrographic system which includes accessories for every application in high-magnification photography.

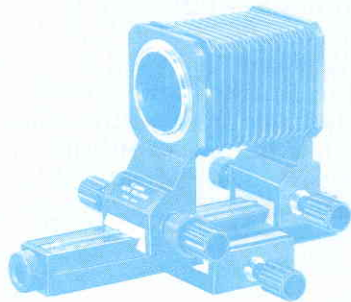

Accessories

1. Angle Finder A2 and B
2. Eyecup 4S
3. Magnifier S
4. Camera Holder F3
5. Macrophoto Coupler FL55 and FL58
6. Lens Hood BS-55
7. Microphoto Hood
8. Photomicro Unit F
9. Slide Duplicator
10. Handy Stand F
11. Gadget Bag 4-type
12. Gadget Bag G-1
13. Canon Release 30
14. Canon Release 50
15. 55mm filters
16. 58mm Close-up Lenses (240, 450)
17. 55mm Close-up Lenses (240, 450)
18. Macrophoto Lens 20mm f/3.5
19. Macrophoto Lens 35mm f/2.8
20. Duplicator 8
21. Duplicator 16
22. Duplicator 35
23. Focusing Rail
24. Macro Stage





26



29

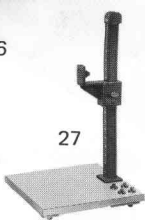

27

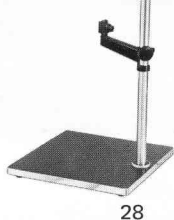

28

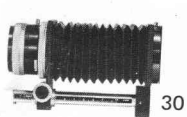

30

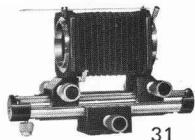

31

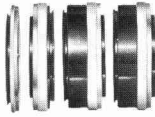

32



33



34



35



36

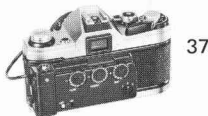

37



38



39

25. Roll Film Stage
26. Double Cable Release
27. Copy Stand 5
28. Copy Stand 4
29. Auto Bellows
30. Bellows M
31. Bellows FL
32. Extension Tube M Set
33. Dioptric Adjustment Lenses (10 kinds)
34. Speedlite 155A
35. Speedlite 199A
36. Power Winder A
37. Data Back A
38. Action Case A
39. Holder for Gelatin Filter with Filter Holder Adapter and Hoods